

# Hubbell™

Marine Products Division

Model MTX

## Tankless On Demand Electric Water Heater

Available Up To 54 KW in Single or Three Phase Voltages

### Marine Approvals

- American Bureau of Shipping (ABS) Type Approved
- ABS Approval eliminates costly delays and uncertainties during ship inspection

### Heavy Duty Construction

- Simple to specify and easy to operate
- Factory wired electrical controls provide trouble-free installation and operation

### Weight and Space Saving

- Significantly reduces weight and saves space compared to storage tank water heaters
- On demand heating eliminates costly and cumbersome storage tanks
- Instantaneous design reduces stand-by heat loss and lowers operating costs

### Reliable

- Engineered for your specific application to ensure reliable operation
- Constructed with high grade materials to ensure long operating life



The Hubbell Model MTX Tankless Water Heater is the perfect choice for Marine applications.

- ✓ SAVES WEIGHT
- ✓ SAVES SPACE
- ✓ SAVES TIME

### Tankless On Demand Water Heater for Marine Applications

The Hubbell MTX Tankless model is a highly reliable and easily maintained electric water heater designed for operation in a marine application. The Hubbell MTX Tankless is compact, highly efficient, takes up minimal space, and reduces operating costs. Hubbell's vast experience, meticulous engineering, and advanced manufacturing processes ensure that you can rely on the MTX Tankless for your water heating needs in even the most demanding and critical applications. It makes sense to specify and install a Hubbell MTX Tankless model for your heating requirements, and as the owner you will be provided with a quality product that is long lasting, trouble-free, and energy efficient.

### High Efficiency Compact Electric Tankless Water Heater



ISO 9001:2008



**Hubbell** The Electric Heater Company

P.O. Box 288 ■ Stratford, CT 06615-0288  
Phone: 203-378-2659 ■ FAX: 203-378-3593  
info@hubbellheaters.com ■ [www.hubbellheaters.com](http://www.hubbellheaters.com)

## Hubbell Tankless Features

### How It Works

The Hubbell Model MTX electric tankless water heater contains high powered heating elements that heat water only when there is demand for hot water. When hot water is needed, a built in flow sensor measures the exact flow rate, and that data combined with temperature readings at the heater's inlet and outlet are processed by the electronic temperature controller. This data is continuously transmitted to the temperature controller, which constantly calculates the precise amount of power (kW) needed to achieve the desired temperature. A zero cross over firing signal is sent to the fast acting triacs in order to modulate the heating elements to the precise level needed to meet demand. The Hubbell tankless heater uses only as much power as is needed, while delivering accurate and consistent hot water temperature.

### Heater Overview - 3 Element Model Shown

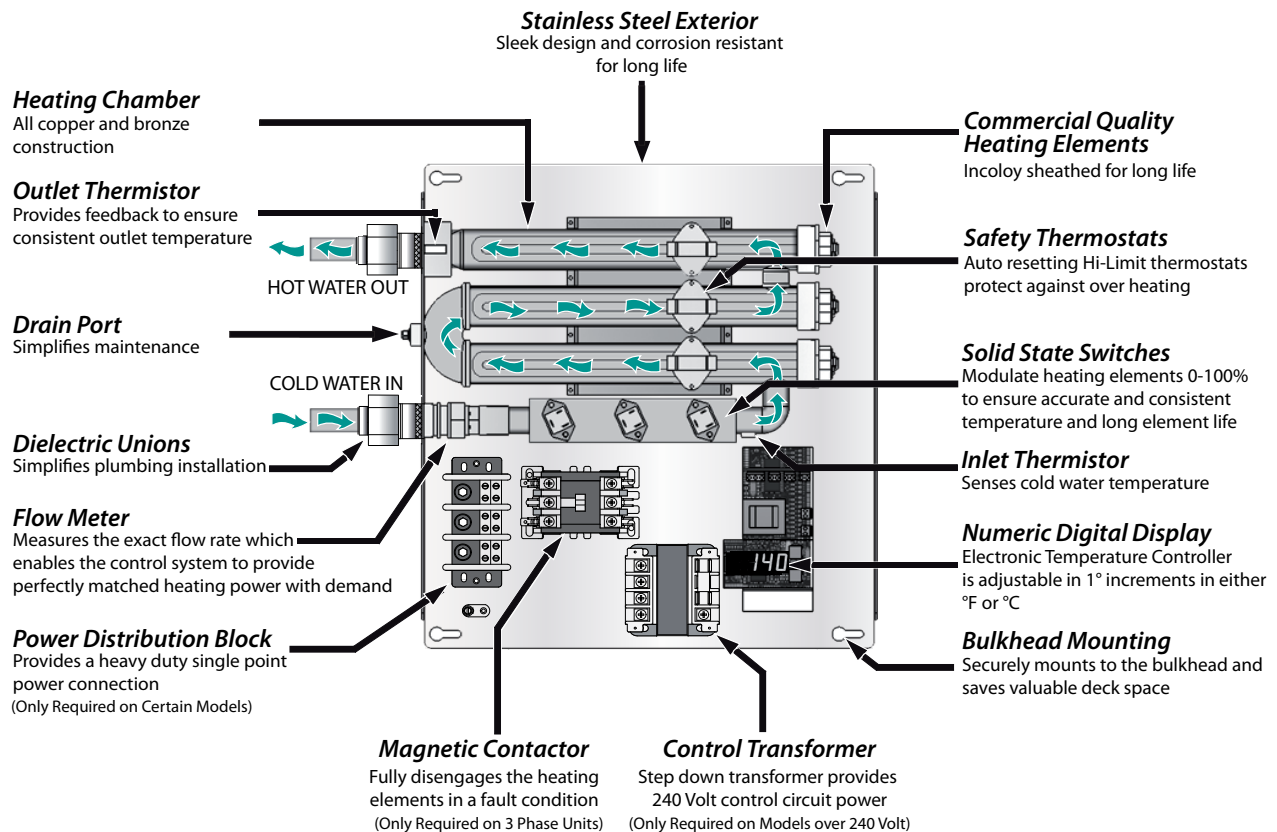

### Tankless Model MTX Standard Specifications

<b>Heating Chamber:</b>	Copper and Bronze	<b>Hi-Limit:</b>	200°F (Fixed)
<b>Capacities:</b>	5 thru 54 kW	<b>Design WP:</b>	100 psi
<b>Mounting:</b>	Bulkhead Mounted	<b>Design TP:</b>	300 psi
<b>Voltages:</b>	208 thru 600 Volt 50/60 Hz	<b>Elements:</b>	Incoloy 800
<b>Phase:</b>	1 $\Phi$ and 3 $\Phi$ (balanced)	<b>Standby Power:</b>	< 3 Watts
<b>Power Factor:</b>	0.999	<b>Chamber</b>	5 Year
<b>Thermal Efficiency:</b>	98% +	<b>Electrical Warranty:</b>	1 Year
<b>Inlet/Outlet Size:</b>		<b>Enclosure:</b>	304 Stainless Steel Brushed Finish
MTX:	3/4" Dielectric Union Copper Sweat	<b>Approvals:</b>	ABS, cULus, UL EPH ANSI/NSF 5
MHX:	1" Dielectric Union Copper Sweat		
<b>Min/Max Flow:</b>			
MTX:	0.2 GPM Min, 8.0 GPM Max		
MHX:	0.5 GPM Min, 40 GPM Max		
<b>Thermostat Range:</b>	32 -194°F / 0-90°C		

### Technical Features

#### Temperature Controller

A sophisticated electronic temperature controller with LED digital display provides the user interface. The temperature controller processes all flow and temperature data and calculates the precise amount of power needed to meet demand.

#### Operator Control Capabilities

✓	<b>Power Limiting:</b>	Allows the operator to reduce the power consumption by any percentage to provide installation and operational flexibility and savings.
✓	<b>Diagnostics:</b>	Display inlet and outlet temperatures, flow rate and error codes to assist in troubleshooting.
✓	<b>Cost Calculator:</b>	Determine the exact cost of operating the heater. Input your cost per KW-Hr and the controller displays total KW-HRs consumed, total cost of operation, and total hot water usage (shown in gallons or liters).
✓	<b>Temperature Control:</b>	Set the digital display to the desired water temperature in °F or °C. Fully adjustable in 1° increments from 32-194°F (0-90°C). A user adjustable +/- 3° calibration feature provides additional control for superior accuracy.

#### Full Heater Modulation

Each heating element is switched on/off using a fast acting solid state triac with zero cross over firing control. This switching schema provides full modulation of each heating element, ensuring that the precise amount of heat is added to meet demand. To improve operating efficiency and component longevity, each triac is mounted to a heat sink located on the incoming supply piping so that heat generated by the triac during the switching process is dissipated into the water.

#### Proper Power Integrity

All Hubbell tankless water heaters, including all 3 phase models, are engineered to operate as a balanced load and operate at 0.999 Power Factor. All Hubbell 3 phase models are designed for 3 wire (3 live, 1 ground) and 4 wire power systems and draw equal current across all conductors to maintain the power integrity of the users electrical system. Hubbell does not recommend the use of heaters that operate as an unbalanced load, as is common with staged heaters designed for star systems (3 live, 1 neutral, 1 ground) that require use of the neutral leg. All load switching in Hubbell tankless models is performed as zero cross over, eliminating phase angle firing interference and associated EMI issues.

#### Full Resource Staging

The Hubbell tankless control schema ensures that usage is equalized across all heating circuits. To achieve this, once the controller has calculated the precise amount of kW required, all circuits are energized in a staggered fashion such that each circuit is proportionally and independently energized and then time staggered between circuits. This Full Resource Staging Schema reduces EMI output, increases component longevity, and provides highly accurate and consistent hot water temperatures. For three phase models, all circuits are fully modulated and synchronized to operate as a balanced load.

#### Shipboard Machinery Control Integration

**Remote Control:** Ability to remotely enable or inhibit the heating operation of the unit using one of the following two methods:

1. Customer supplied 24VDC signal is user configured for either Inhibit Mode or Normal Operation Mode.
2. Customer supplied volt free contact is user configured for either Inhibit Mode or Normal Operation Mode.

**Priority Control:** An integrated SPDT potential free dry contact (NO/NC 10A @ 240VAC) energizes when the unit is heating and de-energizes when not heating. This feature is useful when it is desirable to give the water heater priority over another electrical load to ensure that both are not operational at the same time.

### Options

- A. High flow construction specify model MHX for up to 40 GPM flow (min 0.5 GPM actuation).
- B. Type 316L stainless steel heating chamber for added corrosion resistance.
- C. Special construction features available. Consult factory.
- D. Inlet/Outlet assembly simplifies installation and includes unions, shut offs, checkvalve, drain and relief valve ports.
- E. NEMA 4x construction when heater is located in a wet environment. Overall dimensions 24" x 20" x 6"
- F. Heating chamber built to ASME Section VIII and "UM" stamped.
- G. Remote Control Display allows the heater to be installed in remote location. The 3" x 5" NEMA 4 display enclosure can be located up to 250' from the heater and gives the operator full remote control and monitoring capabilities.
- H. Optional Inlet/Outlet union for connection to IPS pipe sizes. Specify customer connection as sil-braze or NPT.
- I. Special construction for use onboard Military Naval Vessels including shock, vibration and EMI qualifications.
- J. Factory supplied manifold single point connection for redundancy and high demand applications.

#### Manifold Assembly Option

Single point connection for redundancy and high demand applications.

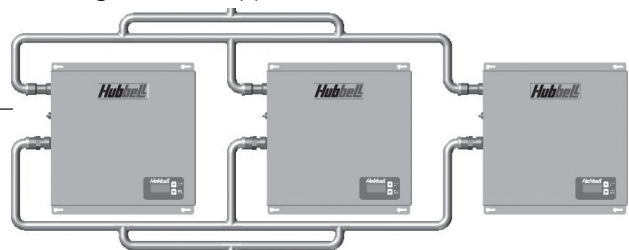

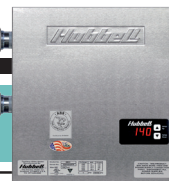

Outline Dimensions and Model Selection

8-27 KW Models (2 and 3 Element)

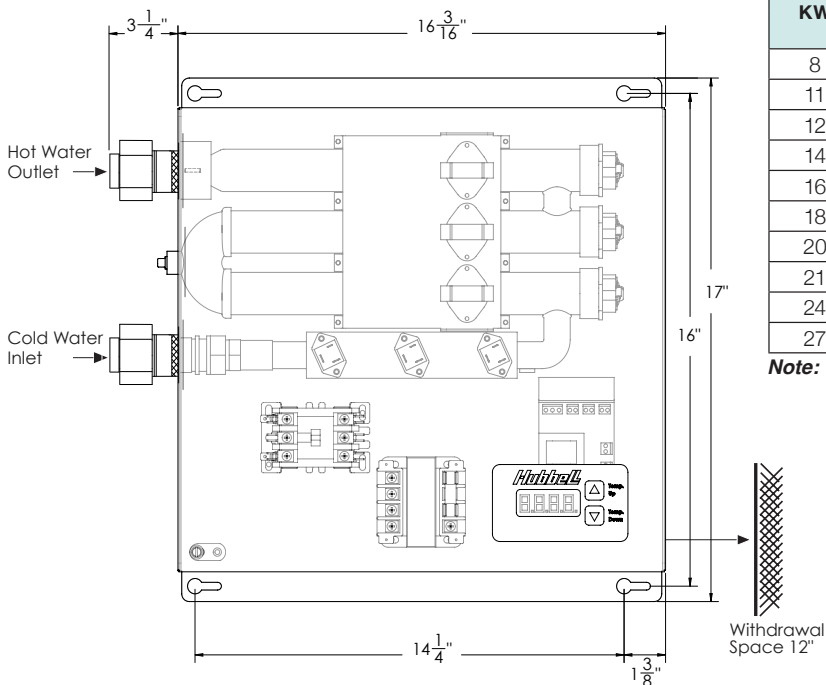

KW	3 Phase Voltages					1 Phase Voltages	
	208V	240V	440V	480V	600V	208V	240V
8						✓ (2)	
11	✓ (3)						✓ (2)
12	✓ (3)					✓ (2)	
14		✓ (3)				✓ (2)	✓ (2)
16	✓ (3)	✓ (3)	✓ (3)			✓ (3)	✓ (2)
18	✓ (3)		✓ (3)	✓ (3)		✓ (3)	✓ (2)
20	✓ (3)		✓ (3)			✓ (3)	
21		✓ (3)	✓ (3)	✓ (3)	✓ (3)		✓ (3)
24		✓ (3)	✓ (3)	✓ (3)	✓ (3)		✓ (3)
27		✓ (3)	✓ (3)	✓ (3)	✓ (3)		✓ (3)

Note: • Chart indicates three element (3) and two element (2) model types  
• Additional 440V 3Φ sizes available including 5, 6, 7 and 13 KW

Side View

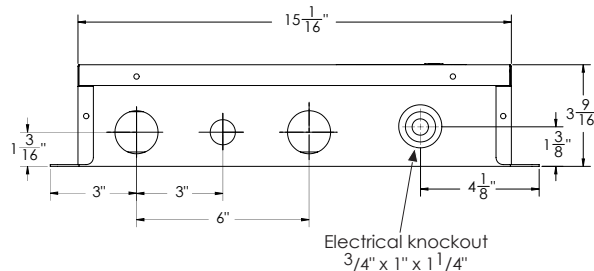

Pressure Drop: 3 psi @ 8 GPM    Dry Weight: 21 Lbs    Wet Weight: 21.5 Lbs    Shipping Weight: 24 Lbs

24-54 KW Models (6 Element)

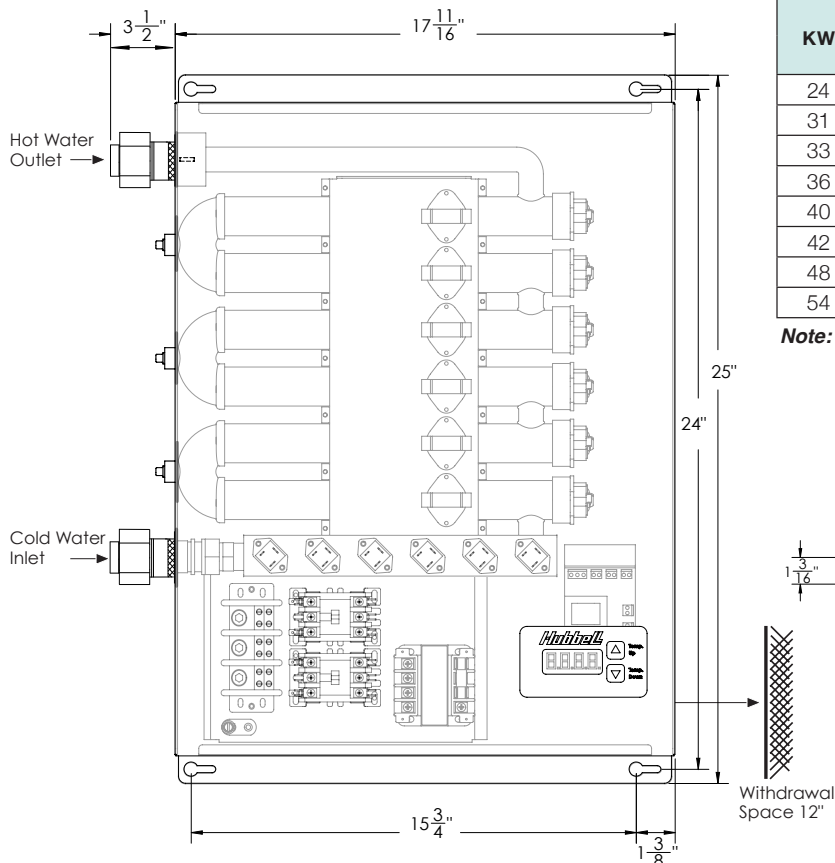

KW	3 Phase Voltages					1 Phase Voltages	
	208V	240V	440V	480V	600V	208V	240V
24	✓ (6)					✓ (6)	
31	✓ (6)		✓ (6)			✓ (6)	
33		✓ (6)					✓ (6)
36	✓ (6)		✓ (6)	✓ (6)		✓ (6)	
40	✓ (6)		✓ (6)			✓ (6)	
42		✓ (6)	✓ (6)	✓ (6)	✓ (6)		✓ (6)
48	✓ (6)	✓ (6)	✓ (6)	✓ (6)	✓ (6)	✓ (6)	✓ (6)
54		✓ (6)	✓ (6)	✓ (6)	✓ (6)		✓ (6)

Note: All models shown in this chart are six element (6) model types

Side View

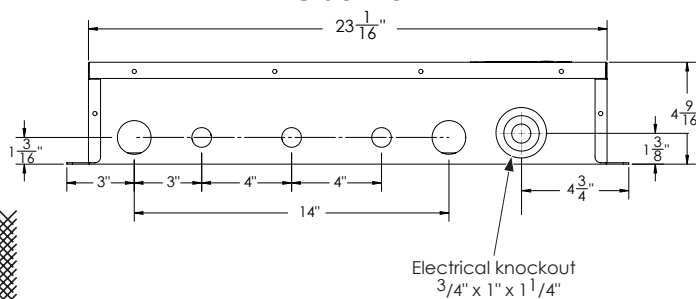

Pressure Drop: 4 psi @ 8 GPM    Dry Weight: 38 Lbs    Wet Weight: 39 Lbs    Shipping Weight: 42 Lbs

### Heating Capacity and Amperage Chart

KW Rating	Heating Capability in GPM at °F Temperature Rise (°FΔT)										MAX Amps (at 100% heater output)						
	20° ΔT	30° ΔT	40° ΔT	60° ΔT	70° ΔT	80° ΔT	100° ΔT	110° ΔT	120° ΔT	140° ΔT	3 Phase Voltages					1 Phase Voltages	
	208V	240V	440V	480V	600V	208V	240V										
8	2.73	1.82	1.36	0.91	0.78	0.68	0.55	0.50	0.45	0.39	-	-	-	-	-	38	-
11	3.75	2.50	1.88	1.25	1.07	0.94	0.75	0.68	0.63	0.54	31	-	-	-	-	-	46
12	4.09	2.73	2.05	1.36	1.17	1.02	0.82	0.74	0.68	0.58	33	-	-	-	-	58	-
14	4.78	3.18	2.39	1.59	1.36	1.19	0.96	0.87	0.80	0.68	-	34	-	-	-	67	58
16	5.46	3.64	2.73	1.82	1.56	1.36	1.09	0.99	0.91	0.78	44	39	21	-	-	77	67
18	6.14	4.09	3.07	2.05	1.75	1.54	1.23	1.12	1.02	0.88	50	-	24	22	-	87	75
20	6.82	4.55	3.41	2.27	1.95	1.71	1.36	1.24	1.14	0.97	56	-	26	-	-	96	-
21	7.17	4.78	3.58	2.39	2.05	1.79	1.43	1.30	1.19	1.02	-	51	28	25	20	-	88
24	8.19	5.46	4.09	2.73	2.34	2.05	1.64	1.49	1.36	1.17	67	58	32	29	23	115	100
27	9.21	6.14	4.61	3.07	2.63	2.30	1.84	1.67	1.54	1.32	-	65	36	33	26	-	113
31	10.58	7.05	5.29	3.53	3.02	2.64	2.12	1.92	1.76	1.51	86	-	41	-	-	149	-
33	11.26	7.51	5.63	3.75	3.22	2.81	2.25	2.05	1.88	1.61	-	79	-	-	-	-	138
36	12.28	8.19	6.14	4.09	3.51	3.07	2.46	2.23	2.05	1.75	100	-	47	43	-	173	-
40	13.65	9.10	6.82	4.55	3.90	3.41	2.73	2.48	2.27	1.95	111	-	53	-	-	192	-
42	14.33	9.55	7.17	4.78	4.09	3.58	2.87	2.61	2.39	2.05	-	101	55	51	41	-	175
48	16.38	10.92	8.19	5.46	4.68	4.09	3.28	2.98	2.73	2.34	133	116	63	58	46	230	200
54	18.42	12.28	9.21	6.14	5.26	4.61	3.68	3.35	3.07	2.63	-	130	71	65	52	-	225

**Note:** • Unshaded flows specify Base Model MTX, shaded flows must specify Base Model MHX due to high flow rate.  
 • Alternate voltages including 277, 380, 415, 460 and 575 volt available. Please consult factory for exact KW availability in these voltages.

### Sizing Formulas

**Step 1** Solve for the unknown using formulas below.

#### Variables To Solve For:

##### KW Requirement:

$$\text{_____ GPM} \times \text{_____ } ^\circ\text{F}\Delta\text{T} \times 0.1465 = \text{_____ KW}$$

##### Temperature Rise:

$$\text{_____ KW} \times 6.824 \div \text{_____ GPM} = \text{_____ } ^\circ\text{F}\Delta\text{T}$$

##### Flow Rate:

$$\text{_____ KW} \times 6.824 \div \text{_____ } ^\circ\text{F}\Delta\text{T} = \text{_____ GPM}$$

### Step 2

Choose the Tankless model with the KW rating which meets the peak demand (GPM) and required temperature rise (°FΔT) for your application.

### Step 3

Choose the voltage and phase power supply available. Note the total amperage draw of the unit and verify availability.

### Voltage De-Rating Factors

Rated Voltage	Applied Voltage	De-Rating Factor
600 V	575 V	92%
600 V	550 V	84%
480 V	460 V	92%
240 V	230 V	92%
240 V	220 V	84%

When the actual supply voltage (applied voltage) is different than the design voltage (rated voltage) the resulting KW output will be affected. Please see the chart for typical voltage de-rating factors, or use the following formula.

$$\frac{\text{Applied Voltage}^2}{\text{Rated Voltage}^2} \times \text{Rated KW} = \text{KW output at applied voltage}$$

### Model Number Designation

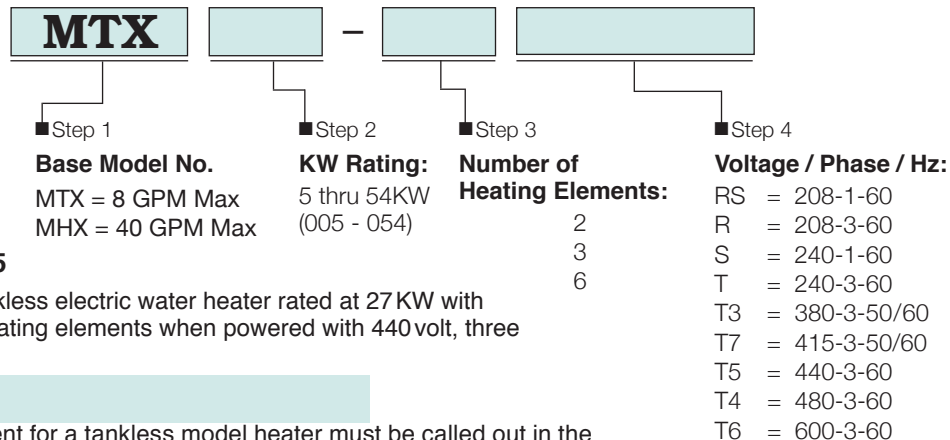

#### Example: MTX027-3T5

A Hubbell tankless electric water heater rated at 27 KW with a total of 3 heating elements when powered with 440 volt, three phase, 60Hz.

### Option Note

Any and all optional equipment for a tankless model heater must be called out in the written specifications. A model number in and of itself does not reflect any optional equipment selected.

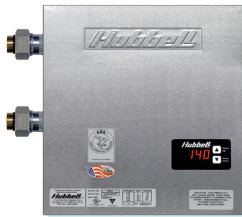

## Model MTX TANKLESS

# Master Specification

SHIP NAME \_\_\_\_\_

ENGINEER / NAVAL ARCHITECT / SPECIFIER \_\_\_\_\_

SHIPYARD \_\_\_\_\_

CONTRACTOR / SHIP CHANDLER \_\_\_\_\_

### General

Provide a quantity of \_\_\_\_\_ packaged type instantaneous electric tankless water heater(s) Model No. MTX\_\_\_\_\_ as manufactured by HUBBELL Electric Heater Co., Stratford, CT. The entire unit is packaged ready for plumbing and electrical service connections and shall be Type Approved by the American Bureau of Shipping (ABS) and bear the cULus listing mark certifying the entire unit to UL499, UL EPH Sanitation listed to ANSI/NSF Standard 5 and CSA C22.2 No. 64-M91 (single phase units) and CSA C22.2 No. 88 (three phase units).

### Heating Chamber

The heating chamber shall be all sil-brazed copper and bronze construction. ( Optional Specification: Type 316L Stainless Steel). A plastic heating chamber shall not be acceptable. Water heater heating chamber shall be rated for a maximum allowable working pressure of 100 psi. The heating chamber and all electrical controls shall be completely enclosed in a heavy gauge Type 304 stainless steel case.

### Heating Capacity

The tankless heater shall be rated at \_\_\_\_\_ KW which will heat \_\_\_\_\_ GPM of water at \_\_\_\_\_ °F rise ( \_\_\_\_\_ ° to \_\_\_\_\_ °F). Heaters that require the use of a flow restrictor or specialized aerator shall not be acceptable.

### Electrical

The tankless heater shall be designed to operate at \_\_\_\_\_ volts, \_\_\_\_\_ phase, 50/60Hz balanced power and shall draw equal amperage across all phases at all times. For 3 phase heaters, power shall be a 3 wire (3 live, 1 ground) or a 4 wire (3 live, 1 neutral, 1 ground) system that does not require a neutral leg. The heater will draw \_\_\_\_\_ amps only when operating at full power. The immersion heating elements shall be high quality incoloy sheathed and sized to obtain the rated capacity. Each element is to be operated using zero cross over solid state controls. The heating elements shall be fully modulated from 0-100% to provide precise temperature control through the full range of flows. A Hi-Limit thermostat with automatic reset shall be factory installed to disconnect each heating element in the event of an over-temperature condition. An electronic digital display temperature controller shall be user adjustable in 1° increments in either °F or °C and shall display flow rate, outlet temperature, inlet temperature and provide error indication. A turbine-type flow meter shall be factory installed to provide precise temperature control for water flows as low as 0.2 GPM up to a maximum flow of 8 GPM. Heaters that require greater than 0.2 GPM flow for actuation or heaters that utilize on/off flow switch technology or restrict flow shall not be acceptable. ( Optional Specification: High Flow Model MHX, provides up to 40 GPM flow with minimum actuation at 0.5 GPM ).

### Warranty

Hubbell shall warranty all electrical components against defects in workmanship and material for a period of one (1) year from date of start-up, and the heating chamber for five (5) years from date of start-up, provided that the unit is started within three (3) months of date of shipment and installed and operated within the scope of the heater's design and operating capability. Labor is not covered under warranty. Each heater shall be shipped with a complete set of installation and operating instructions including spare parts list and drawing. All fabrication and assembly shall be performed in the U.S.A.

### Options

In addition, the water heater shall be supplied with the following options:

- Option \_\_\_\_\_
- Option \_\_\_\_\_
- Option \_\_\_\_\_

ISO 9001:2008



*Committed to continuous improvements*

Continuing research results in product improvement; therefore these specifications are subject to change without notice. For the most updated information, consult the factory.

Made in the U.S.A.



# Hubbell™

## Marine Products Division

The Electric Heater Company ■ P.O. Box 288 ■ Stratford, CT 06615-0288

Phone: 203-378-2659 ■ FAX: 203-378-3593 ■ info@hubbellheaters.com ■ www.hubbellheaters.com